

# PANELS & VENEER

CONTEMPORARY/ENGINEERED







## BAMBOO PANELS & VENEER

Crafted to deliver a luxurious, contemporary look that exudes sustainability and natural authenticity, our engineered Bamboo panels and veneer are an eco-friendly alternative to traditional timber products.

Our engineered laminated bamboo panels come in either a horizontal or vertical pattern and can be matched to any length or thickness to create modern, sophisticated cabinetry and joinery items including cladding, furniture, stairs and benchtops.

Visually appealing and hand-crafted, our Bamboo Woven Veneer is weaved in narrow strips and has two standard styles; Basket Weave and Herringbone. Offering a wide range of sizes it is suited to an array of projects including flooring, cabinetry and joinery and being resistant to moisture makes it an ideal choice for kitchens and bathrooms.

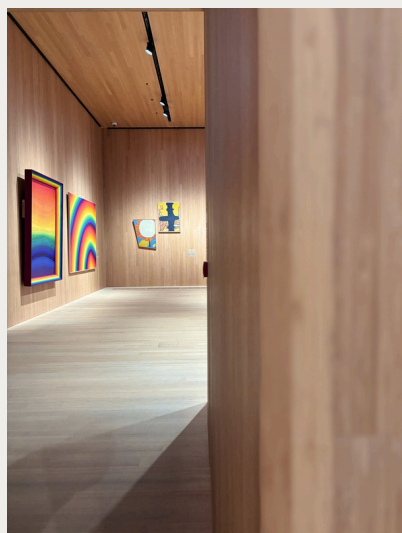





## BAMBOO VENEER

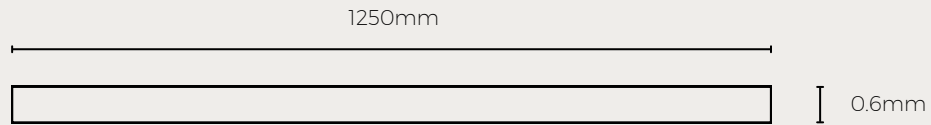

Note: Profile drawing are indicative and not to scale.



Horizontal natural



Strandwoven carbonised



Vertical dark carbonised

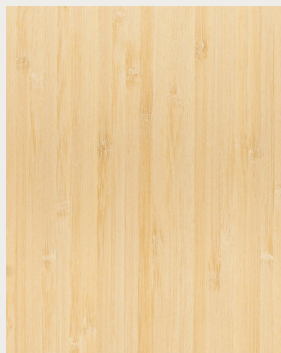

Vertical natural



Vertical light carbonised

Series	Colour	Length	Width	Thickness	SKU
Vertical Grain	Carbonised Dark	2500mm	1250mm	0.6mm	VENE-VERT-0.6MM-W1250-H2500-CD-C-B
	Carbonised Light				VENE-VERT-0.6MM-W1250-H2500-CL-C-B
	Medium Carbonised				VENE-VERT-0.6MM-W1250-H2500-MC-C-B
	Natural				VENE-VERT-0.6MM-W1250-H2500-N-C-B
Horizontal Grain	Carbonised Dark	2500mm	1250mm	0.6mm	VENE-HORI-0.6MM-W1250-H2500-CD-C-B
	Carbonised Light				VENE-HORI-0.6MM-W1250-H2500-CL-C-B
	Medium Carbonised				VENE-HORI-0.6MM-W1250-H2500-MC-C-B
	Natural				VENE-HORI-0.6MM-W1250-H2500-N-C-B
Strandwoven	Carbonised Dark	2500mm	1250mm	0.6mm	VENE-STRA-0.6MM-W1250-H2500-CD-C-B
	Carbonised Light				VENE-STRA-0.6MM-W1250-H2500-CL-C-B
	Medium Carbonised				VENE-STRA-0.6MM-W1250-H2500-MC-C-B
	Natural				VENE-STRA-0.6MM-W1250-H2500-N-C-B



## BAMBOO PLY

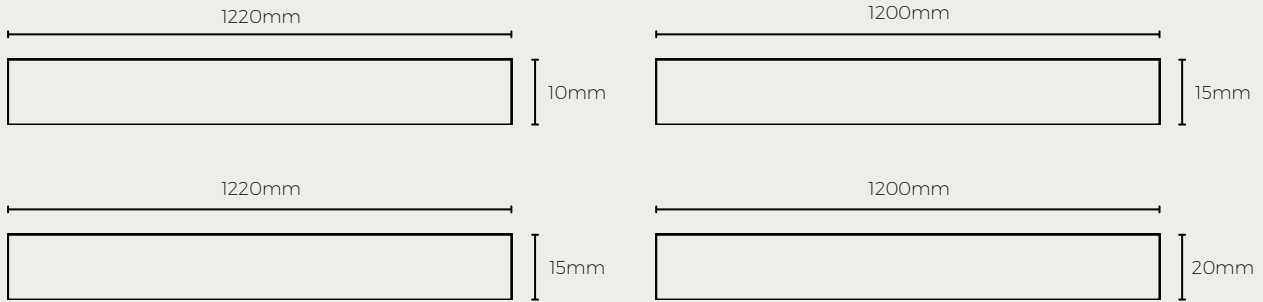

Note: Profile drawing are indicative and not to scale.



Horizontal 10mm dark carbonised



Horizontal 20mm light carbonised



Vertical 15mm dark carbonised

Colour	Length	Width	Thickness	Sku
Vertical Grain	2440mm	1200mm	10mm	PLY-VERT-10MM-C-W1200-H2440-C-R
				PLY-VERT-10MM-C-W1200-H2440-N-R
		1220mm		PLY-VERT-10MM-C-W1220-H2400-C-R
				PLY-VERT-10MM-C-W1220-H2400-N-R
	2440mm	1200mm	15mm	PLY-VERT-15MM-C-W1200-H2440-C-R
				PLY-VERT-15MM-C-W1200-H2440-N-R
		1220mm		PLY-VERT-15MM-C-W1220-H2400-C-R
				PLY-VERT-15MM-C-W1220-H2400-N-R
	2440mm	1200mm	20mm	PLY-VERT-20MM-C-W1200-H2440-C-R
				PLY-VERT-20MM-C-W1200-H2440-N-R
		1220mm		PLY-VERT-20MM-C-W1220-H2400-C-R
				PLY-VERT-20MM-C-W1220-H2400-N-R
	2440mm	1200mm	30mm	PLY-VERT-30MM-C-W1200-H2440-C-R
				PLY-VERT-30MM-C-W1200-H2440-N-R
		1220mm		PLY-VERT-30MM-C-W1220-H2400-C-R
				PLY-VERT-30MM-C-W1220-H2400-N-R



## BAMBOO PLY

Colour	Length	Width	Thickness	Sku
Horizontal Grain	2440mm	1200mm	10mm	PLY-HORI-10MM-C-W1200-H2440-C-R
				PLY-HORI-10MM-C-W1200-H2440-N-R
		1220mm		PLY-HORI-10MM-C-W1220-H2400-C-R
				PLY-HORI-10MM-C-W1220-H2400-N-R
	2440mm	1200mm	15mm	PLY-HORI-15MM-C-W1200-H2440-C-R
				PLY-HORI-15MM-C-W1200-H2440-N-R
		1220mm		PLY-HORI-15MM-C-W1220-H2400-C-R
				PLY-HORI-15MM-C-W1220-H2400-N-R
	2440mm	1200mm	20mm	PLY-HORI-20MM-C-W1200-H2440-C-R
				PLY-HORI-20MM-C-W1200-H2440-N-R
		1220mm		PLY-HORI-20MM-C-W1220-H2400-C-R
				PLY-HORI-20MM-C-W1220-H2400-N-R
	2440mm	1200mm	30mm	PLY-HORI-30MM-C-W1200-H2440-C-R
				PLY-HORI-30MM-C-W1200-H2440-N-R
		1220mm		PLY-HORI-30MM-C-W1220-H2400-C-R
				PLY-HORI-30MM-C-W1220-H2400-N-R



## BAMBOO BENEFITS



SOIL EROSION  
PREVENTION &  
RESTORATION

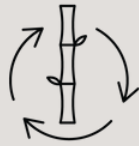

ZERO-WASTE  
LIFE CYCLE



GREENHOUSE  
GAS EMISSIONS

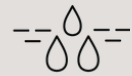

NATURAL  
WATER  
PURIFICATION



SHORT HARVEST  
CYCLE



SELF-  
REGENERATING  
GROWTH



SUPERIOR WATER  
RETENTION

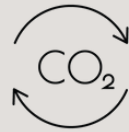

SUPERIOR  
CARBON  
SEQUESTRATION

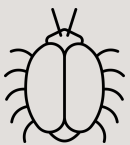

NATURALLY  
RESISTANT  
TO TERMITES



BIODIVERSITY  
PRESERVATION



CLIMATE CHANGE  
MITIGATION

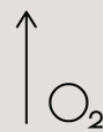

ENHANCED  
OXYGEN  
PRODUCTION





## A BAMBOO LEGACY

At House of Bamboo®, we are carrying on a legacy that was founded last century, when Mark Snyders first began to source environmentally conscious bamboo. Recognised globally as a leading bamboo specialist, we are committed to creating beautiful, environmentally friendly bamboo products and encouraging Australians to embrace the benefits of bamboo.



## A SUSTAINABLE FUTURE

In addition to being House of Bamboo® CEO, Jennifer Snyders also pursues her passion for sustainability by advocating bamboo projects throughout Australia and supporting land regeneration and reforestation.

Having qualified at UNSW with a Bachelor of Science (Architecture), she understands the incredible potential of bamboo and her sense of design and technical understanding has allowed her to develop a range of engineered bamboo products that can out perform timber.

## OFFICE & SHOWROOM NSW



13 Erith Street, Botany NSW 2019

## SHOWROOM QLD



66 Merivale Street, South Brisbane QLD 4101

## CONTACT



For General Enquiries  
[info@houseofbamboo.com.au](mailto:info@houseofbamboo.com.au)



Local or Interstate: 1800 240 996  
International: (+61)2 9666 5703

## ONLINE



[www.houseofbamboo.com.au](http://www.houseofbamboo.com.au)



[@house.of.bamboo.australia](https://www.instagram.com/house.of.bamboo.australia)

house of  
bamboo

EST. 1972